

HERO

9

BLACK



Join the GoPro Movement



@GoPro



@GoPro



@GoPro



facebook.com/GoPro



@GoPro



pinterest.com/GoPro

Contents

Meet Your HERO9 Black	6
Setting Up Your Camera	8
Getting to Know Your GoPro	14
Customizing Your GoPro	27
HERO9 Black Power Tools	36
Using QuikCapture	44
Adding HiLight Tags	46
Setting the Screen Orientation	47
Recording Video	48
Video Settings	53
Taking Photos	56
Photo Settings	63
Capturing Time Lapse	65
Time Lapse Settings	70
Live Streaming + Webcam Mode	73
Exposure Control	74
Controlling Your GoPro With Your Voice	77
Playing Back Your Media	81
Connecting to the GoPro App	85

Contents

Transferring Your Media	87
Setting Your Connections + Preferences	92
Important Messages	101
Resetting Your Camera	103
Mounting Your GoPro	105
Removing the Door	110
Maintenance	112
Battery Information	113
Troubleshooting	116
Tech Specs: Video	117
Tech Specs: Photo	127
Tech Specs: Time Lapse	132
Tech Specs: Protune	137
Customer Support	145
Trademarks	145
Regulatory Information	145

Meet Your HERO9 Black

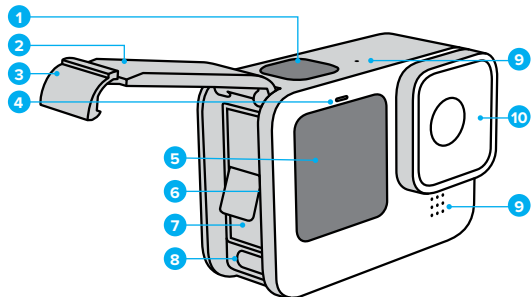

1. Shutter Button 
2. Door
3. Door Latch
4. Status Light
5. Front Screen

6. microSD™ Card Slot
7. Battery
8. USB-C Port
9. Microphone
10. Removable Lens

Meet Your HERO9 Black

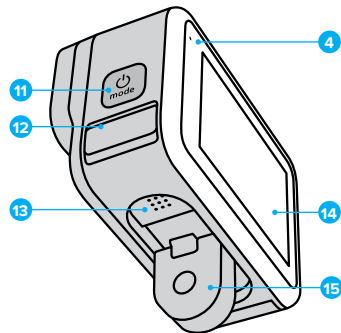

11. Mode Button 
12. Drain Microphone
(Designed to drain water.
This is not a door/latch.
Do not try to open.)

13. Speaker
14. Touch Screen
15. Folding Fingers

Learn how to use the accessories that came with your GoPro.
See [Mounting Your GoPro \(page 105\)](#).

Setting Up Your Camera

MICROSD CARDS

You'll need a microSD card (sold separately) to save your videos and photos. Use a brand-name card that fits these requirements:

- microSD, microSDHC™, or microSDXC™
- Class 10 or UHS-I rating
- Capacity up to 256GB

For a list of recommended microSD cards, visit gopro.com/microsdcards.

Heads Up: Be sure your hands are clean and dry before handling your SD card. Check the manufacturer's guidelines to see your card's acceptable temperature range and other important information.

PRO TIP: Keep your SD card in good condition by reformatting it regularly. This will erase all of your media, so be sure to save it first.

1. Swipe down on the rear screen to access the Dashboard.
2. Swipe left and tap Preferences > Reset > Format SD Card.

To learn how to save your videos and photos, see [Transferring Your Media \(page 87\)](#).

Setting Up Your Camera

RECHARGEABLE BATTERY

For maximum performance, be sure to use the GoPro Rechargeable Battery (HERO9 Black) with your new GoPro.

PRO TIP: There's an easy way to check your battery's status and make sure you're using the right one.

1. Swipe down on the rear screen to access the Dashboard.
2. Swipe left and tap Preferences > About > Battery Info.



WARNING: Although non-GoPro batteries may fit in your HERO9 Black, they'll limit performance. Your camera's performance with any other battery is not guaranteed.

For more important information on battery safety and use, see [Battery Information \(page 113\)](#).

Setting Up Your Camera

MICROSD CARD + BATTERY SETUP

1. Unlock the door latch and flip the door open.



2. With your camera off and battery removed, insert the SD card into the card slot with the label facing the battery compartment.

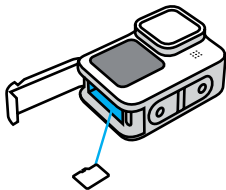

You can eject the card by pressing it into the slot with your fingernail.

Setting Up Your Camera

3. Insert the battery.

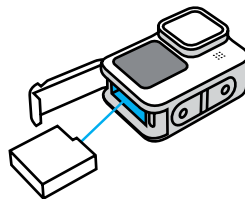

4. Connect your camera to a USB charger or computer using the included USB-C cable.

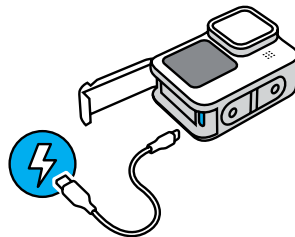

It takes about 3 hours for the battery to fully charge. The camera status light will turn off when it's done. To learn more, see [Battery Information \(page 113\)](#).

PRO TIP: For the fastest charging, use the GoPro Supercharger (sold separately).

Setting Up Your Camera

5. Unplug the cable and shut the door when charging is complete.
Be sure the door latch is closed and locked before using your camera.

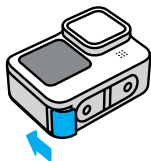

WARNING: Your camera's door is removable. Be sure that the door is securely locked and sealed after closing.

Setting Up Your Camera

UPDATING YOUR CAMERA'S SOFTWARE

To get the latest features and best performance from your GoPro, make sure it's using the most current software.

Updating With the GoPro App

1. Download the app from the Apple® App Store® or Google Play™.
2. Follow the app's on-screen instructions to connect your camera to your mobile device. If new camera software is available, the app will tell you how to install it.

Updating Manually

1. Visit gopro.com/update.
2. Choose *HERO9 Black* from the list of cameras.
3. Select *Update your camera manually* and follow the instructions.

PRO TIP: Want to know what software version you're using? Here's where you can find out.

1. Swipe down on the rear screen to access the Dashboard.
2. Swipe left and tap Preferences > About > Camera Info.

Getting to Know Your GoPro

POWERING ON

Press the Mode button  to turn on your HERO9 Black.

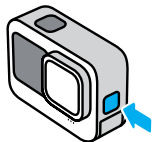

POWERING OFF

Press and hold the Mode button  for 3 seconds to turn it off.

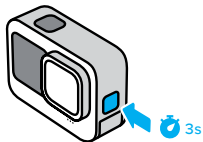

WARNING: Use caution when using your GoPro and its mounts and accessories. Always be aware of your surroundings to avoid injuring yourself and others.

Be sure to follow all local laws including all privacy laws, which may restrict recording in certain areas.

Getting to Know Your GoPro

THE NEW FRONT SCREEN

HERO9 Black's new front screen features a live view from the lens. This makes it easy to capture perfectly framed shots.







1. Recording Time/Photos Remaining
2. Battery Status
3. Current Mode (Video, Photo, or Time Lapse)
4. Capture Settings

Getting to Know Your GoPro

Display Options

The front screen includes four display options that can easily be changed.

1. Swipe down on the rear screen to access the Dashboard.
2. Tap the  to access the front screen settings.
3. Tap the icon of the setting that you want.

Setting	Description
 Full Screen	Displays the live preview as a full-screen shot. The image is cropped for the display, but will be captured without cropping.
 Actual Screen	Displays the live preview from the lens without cropping.
 Status Only	Displays camera status without the live preview from the lens.
 Screen Off	Turns the screen off. Use this setting in dark environments where light from the screen might interfere with your shot. This setting also maximizes battery life.

Getting to Know Your GoPro

USING THE REAR TOUCH SCREEN

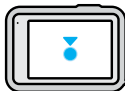

Tap

Select an item to turn it on or off.

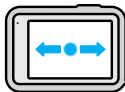

Swipe Left or Right

Switch between Video, Photo, and Time Lapse modes.

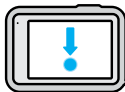

Swipe Down From the Edge of the Screen

Open the Dashboard when your camera is in a landscape orientation.



Swipe Up From the Edge of the Screen

See the last photo or video you captured and access the Media Gallery.

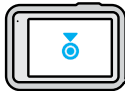

Press and Hold the Capture Screen

Turn on and adjust Exposure Control.

PRO TIP: You can hide your camera's status information and icons on both the front and rear screen by tapping the rear screen. Tap the screen again or press a button to bring it all back.

Getting to Know Your GoPro

CAPTURE MODES

Your GoPro has three main capture modes.

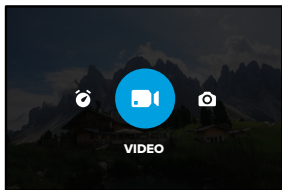

Using the rear touch screen, swipe left or right to the mode you want.

Video

Includes Standard, Activity, Cinematic, and Slo-Mo presets.

To learn more, see [Recording Video \(page 48\)](#).

Photo

Includes Photo, LiveBurst, Burst, and Night presets.

To learn more, see [Taking Photos \(page 56\)](#).

Time Lapse

Includes TimeWarp, Time Lapse, and Night Lapse presets.

To learn more, see [Capturing Time Lapse \(page 65\)](#).

PRO TIP: With the camera on, you can press the Mode button  to switch modes.

Getting to Know Your GoPro

GETTING THE SHOT

1. Simply press the Shutter button  to start recording.

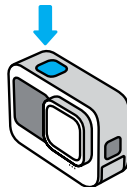

2. Press the Shutter button  again to stop recording (Video, Time Lapse, and Live Streaming only).

Getting to Know Your GoPro

THE TOUCH SCREEN

The rear touch screen gives you access to your camera's capture settings.



1. Current Mode (Video, Photo, or Time Lapse)
2. Recording Time/Photos Remaining
3. Customizable On-Screen Shortcuts
4. Capture Settings
5. Battery Status

Heads Up: The capture settings are not available when you turn your GoPro to take portrait shots. Be sure to choose the settings you want before rotating your camera.

PRO TIP: Press the Mode button  to quickly jump back to this screen from almost anywhere.

Getting to Know Your GoPro

CHANGING PRESETS

Each capture mode has presets that make it easy to switch back and forth between the best mode and settings for your shot.

1. Tap the capture settings.



2. Tap the preset that you want. All of the preset's settings will be locked into your camera and ready to go.

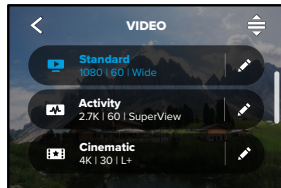

Getting to Know Your GoPro

CUSTOMIZING THE PRESETS

You can change the settings in your presets with just a few taps.

1. With your camera in landscape orientation, tap  next to the preset you want to adjust.

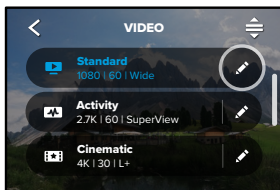

2. Tap the setting that you want to change.

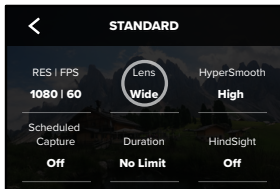

Getting to Know Your GoPro

The on-screen instructions will give you a rundown of your options.

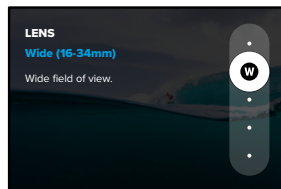

For details on settings, see [Tech Specs \(starting page 117\)](#).

3. Scroll down for the more advanced settings.

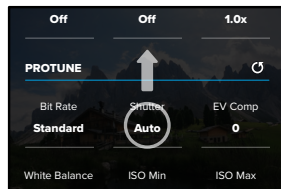

For details on all advanced settings, see [Protune \(starting page 137\)](#).

Getting to Know Your GoPro

4. Tap  to save your changes and return to the presets screen.

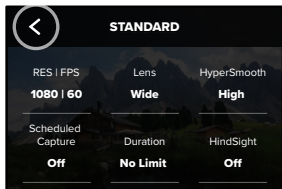

Heads Up: You can't delete the preloaded presets, but you can customize them any way you want. You can also create your own custom presets.

To learn more, see [Creating Your Own Presets \(page 27\)](#).

PRO TIP: From the capture screen, you can press and hold the capture settings to skip straight to the settings menu.

Getting to Know Your GoPro

RESTORING PRESETS TO THEIR ORIGINAL SETTINGS

You can go back to your presets' original settings anytime.

1. Tap .

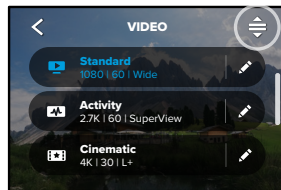

2. Tap .

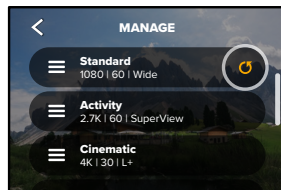



3. Tap Done.

Heads Up: You can also scroll to the end of the list of settings and tap Restore.

Getting to Know Your GoPro

NAVIGATING WITH THE BUTTONS

Although your GoPro is waterproof, the touch screen won't work under water. Use the buttons and front screen to change presets in the mode you're using.

1. With your camera on, hold down the Mode button  and press the Shutter button . A menu will appear on the front screen.
2. Press the Mode button to scroll through the presets.
3. Use the Shutter button to select a preset.

Heads Up: The Dashboard and Media Gallery are not available when navigating with the buttons.

Customizing Your GoPro

CREATING YOUR OWN PRESETS

The perfect capture settings for a day out on the slopes may not be so great when you're recording indoors. Custom presets let you set up and save settings for both so you can switch back and forth in no time.

1. Tap the capture settings, and then scroll to the bottom of the presets list and tap .

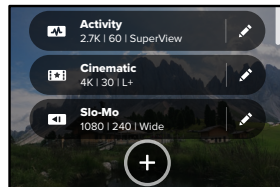

2. Choose a preset mode.

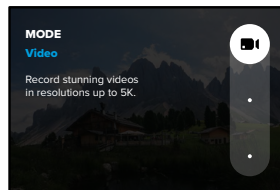

Customizing Your GoPro

Tap a setting to change it.

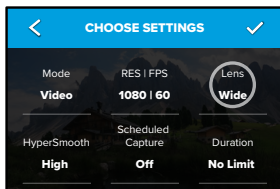

The on-screen instructions will give you a rundown of your options.

For details on all settings, see [Tech Specs \(starting page 117\)](#).

3. Scroll down for the more advanced settings.

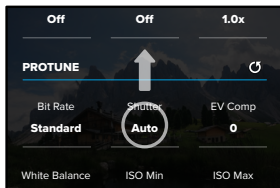

For details on advanced settings, see [Protune \(starting page 137\)](#).

Customizing Your GoPro

4. Tap ✓ when you're finished.

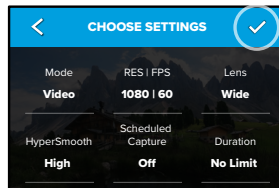

5. Choose an icon and name for your preset.

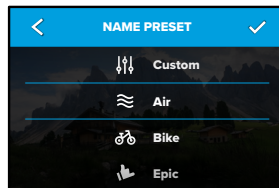

6. Tap ✓ to save your preset.

You may need to fine-tune your presets after trying them out.

Tap  next to the preset to make adjustments.

Customizing Your GoPro

DELETING YOUR PRESET

1. Tap .

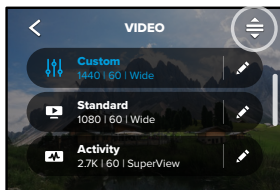

2. Tap .

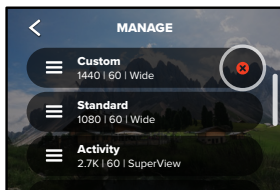

Heads Up: You can also scroll to the end of the list of settings and tap Delete.

Customizing Your GoPro

SUGGESTED SETTINGS

Here are some of the best modes and settings for capturing your favorite activities. Try them as starting points for your presets, and then experiment to find what works best for you.

Activity	Video	Photo
Air	<ul style="list-style-type: none">• 4K60, Wide Lens• 1080p120, Wide Lens• 15x TimeWarp Video	<ul style="list-style-type: none">• Time Lapse Photo (1-second interval)• 1080p120, Wide Lens• Burst (30/3 Rate), Wide Lens
Bike	<ul style="list-style-type: none">• 2.7K60 4:3, Wide Lens• 1440p60, Wide Lens• 15x TimeWarp Video	<ul style="list-style-type: none">• Time Lapse Photo (5-second interval), Wide Lens
Indoor	<ul style="list-style-type: none">• 1440p30, Wide Lens• 1080p30, Wide Lens	<ul style="list-style-type: none">• Photo or Continuous Photo, Wide Lens
Motor	<ul style="list-style-type: none">• 2.7K60 4:3, Wide Lens• 1440p60, Wide Lens• 15x TimeWarp Video	<ul style="list-style-type: none">• Time Lapse Photo (5-second interval), Wide Lens
Mounted	<ul style="list-style-type: none">• 5K30, Wide Lens• 1440p60, Wide Lens• Auto TimeWarp Video	<ul style="list-style-type: none">• Time Lapse Photo (5-second interval), Wide Lens
Outdoor	<ul style="list-style-type: none">• 5K30, Wide Lens• 1440p60, Wide Lens• 10x TimeWarp Video	<ul style="list-style-type: none">• Photo or Continuous Photo, Wide Lens

Customizing Your GoPro

Activity	Video	Photo
POV*	<ul style="list-style-type: none">• 1440p60, Wide Lens• 1440p120, Wide Lens• 15x TimeWarp Video	<ul style="list-style-type: none">• Time Lapse Photo (2-second interval), Wide Lens• Burst (30/3 Rate), Wide Lens
Selfie	<ul style="list-style-type: none">• 4K30 4:3, Narrow Lens• 1440p60, Narrow Lens	<ul style="list-style-type: none">• Photo, Narrow Lens, SuperPhoto, Photo Timer
Snow	<ul style="list-style-type: none">• 4K60, Wide Lens• 1080p120, Wide Lens• 15x TimeWarp Video	<ul style="list-style-type: none">• Time Lapse Photo (1-second interval), Wide Lens• Burst (30/3 Rate), Wide Lens
Trail	<ul style="list-style-type: none">• 4K30 4:3, Wide Lens• 1440p60, Wide Lens• 15x TimeWarp Video	<ul style="list-style-type: none">• Photo, Wide Lens
Travel	<ul style="list-style-type: none">• 5K30, Wide Lens• 1440p60, Wide Lens• 10x TimeWarp Video	<ul style="list-style-type: none">• Photo or Continuous Photo, Wide Lens
Water	<ul style="list-style-type: none">• 4K60, Wide Lens• 1080p240, Wide Lens• 1440p60, Wide Lens	<ul style="list-style-type: none">• Time Lapse Photo (2- or 5-second interval), Wide Lens• Burst (30/6 Rate), Wide Lens

*Point-of-view (POV) shots are those taken from your point of view using a body mount or handheld mount.

Customizing Your GoPro

PERSONALIZING YOUR ON-SCREEN SHORTCUTS

On-screen shortcuts give you quick one-tap access to your camera's capture settings. Each mode has its own default shortcuts, but you can change them to the settings that you use most. You can even set up different shortcuts for each preset.

1. Tap the  next to the preset you want to adjust.

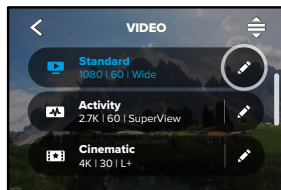

2. Scroll down to the On-Screen Shortcuts.

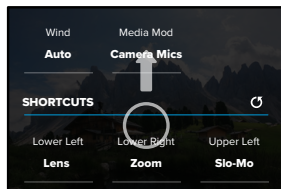

Customizing Your GoPro

3. Tap where you'd like to put your new shortcut.

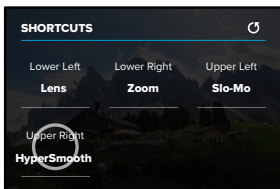

4. Scroll through all of the available shortcuts on the right and choose the one you want.

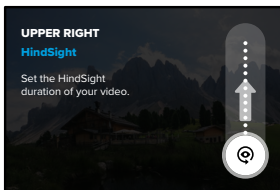

For details on shortcuts, see [Tech Specs \(starting page 117\)](#) and [Protune \(starting page 137\)](#).

Customizing Your GoPro

5. Tap  to save your changes and return to the presets screen.

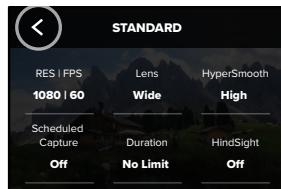

Now you can simply tap the shortcut to change settings.

HERO9 Black Power Tools

HERO9 Black comes with Power Tools—a full suite of smart capture settings that extend the capture options beyond simply pressing the shutter button.

HINDSIGHT

HindSight is a powerful new feature that can capture up to 30 seconds of video before you press the Shutter button. This lets you record key moments even after they happen.

Using HindSight

Imagine your kid making the game-winning play during their big game. This is a moment you don't want to miss. With HindSight on, you can frame your shot, but you don't have to start recording. You can press the Shutter button  after they make the big play. HindSight will save the video it captured before you pressed the Shutter button (up to 30 seconds) and will continue recording until you stop the video.

Setting Up HindSight

1. After choosing a video preset, press and hold the capture settings to go to the settings menu.

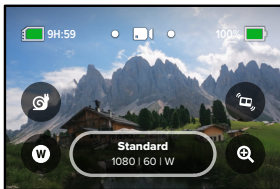

HERO9 Black Power Tools

2. Tap HindSight.

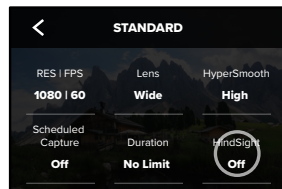

3. Set HindSight for either 15 or 30 seconds.

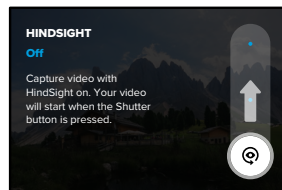

Heads Up: HindSight works by capturing video the entire time that it's on (even when you're not actively recording). Depending on how you use it, HindSight may use your camera's battery capacity faster than recording in normal video mode.

HERO9 Black Power Tools

LIVEBURST

LiveBurst captures a burst of photos both 1.5 seconds before and 1.5 seconds after the Shutter button  is pressed. You can look through the burst to find the perfect shot or share the whole burst as a short video.

Setting Up LiveBurst

1. Swipe to switch to Photo mode.

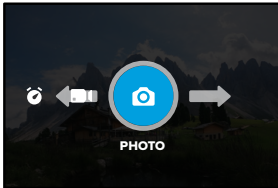

2. Tap the settings.

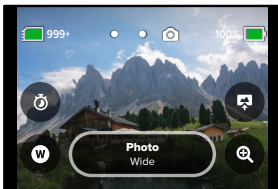

HERO9 Black Power Tools

3. Select LiveBurst from the list of presets.

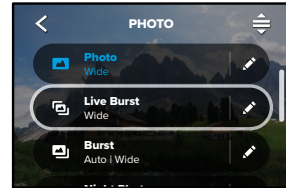

HERO9 Black Power Tools

SCHEDULED CAPTURE

Scheduled capture lets you set your GoPro to automatically turn itself on and capture a shot up to 24 hours in advance. It's available for all presets.

Setting Up Scheduled Capture

1. Press and hold the capture settings on the capture screen to go to the settings menu.



2. Tap Scheduled Capture.

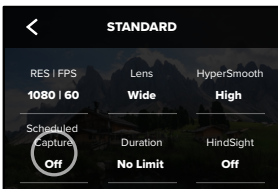

HERO9 Black Power Tools

3. Set when you want your GoPro to capture the shot.

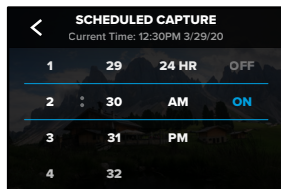

4. After setting the time, you can turn your GoPro off or continue using your camera's other presets.

Heads Up: Your GoPro will stay on after taking the shot. It will turn itself off after idling for the length of time set in Preferences.

1. Swipe down on the rear screen to access the Dashboard.
2. Swipe left and tap Preferences > General > Auto Power Off.

PRO TIP: Use duration capture to choose the shot length when using scheduled capture. Your camera will automatically stop recording after it gets the shot. You'll have to press the Shutter button  to stop recording if you're not using duration capture.

HERO9 Black Power Tools

DURATION CAPTURE

Use duration capture to set how long your GoPro records before it stops. It's available in Video, TimeWarp, Time Lapse, and Night Lapse modes in increments from 15 seconds to 3 hours.

Setting Up Duration Capture

1. Press and hold the capture settings on the capture screen to go to the settings menu.



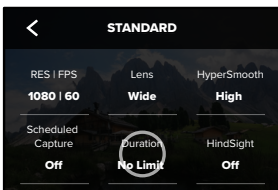

2. Tap Duration.

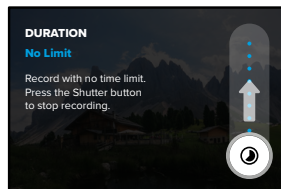

HERO9 Black Power Tools

3. Choose your duration for your shot.



4. Press the Shutter button  to start recording. Your GoPro will automatically stop after recording for the set duration.

Heads Up: Duration capture sets how long your GoPro will record. The length of your final video will vary based on the mode you're using. TimeWarp and time lapse videos will be shorter than the set duration.

PRO TIP: Choose No Limit to capture footage without a time limit. Press the Shutter button to stop recording.

Using QuikCapture

QuikCapture is the fastest and easiest way to power on your GoPro and get the shot. All it takes is the push of the Shutter button.

RECORDING VIDEO WITH QUIKCAPTURE

1. With your camera off, press the Shutter button .

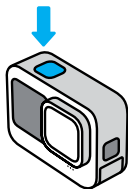

2. Press the Shutter button  again to stop recording and turn off your camera.

Heads Up: When using QuikCapture, your camera will start recording with the settings that you used last.

For more Video options, see [Recording Video \(page 48\)](#).

Using QuikCapture

TAKING TIME LAPSE WITH QUIKCAPTURE

1. With your camera off, press and hold the Shutter button  until your camera turns on (about 3 seconds). It will start recording in the last Time Lapse mode that you used.

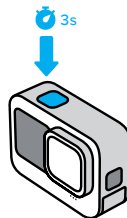

2. Press the Shutter button  again to stop Time Lapse and turn off your camera.

For more Time Lapse options, see [Capturing Time Lapse \(page 65\)](#).



TURNING OFF QUIKCAPTURE

QuikCapture is on by default, but you can turn it off.

1. Swipe down on the rear screen to access the Dashboard.
2. Tap .

PRO TIP: Since it only turns the camera on when it's recording, QuikCapture is a great way to maximize battery life.

Adding HiLight Tags

Mark favorite moments in your videos and photos by pressing the Mode button  during recording or playback. This adds a HiLight Tag  that makes those moments easier to find when you're watching your footage, creating a video, or looking for a certain shot.

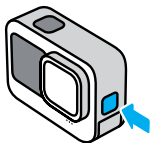

You can also add HiLight Tags by saying, "GoPro, HiLight" when Voice Control is on and by tapping  when watching your footage with the GoPro app.

PRO TIP: The GoPro app looks for HiLight Tags when it creates videos. This helps to ensure that favorite moments are included in your stories.

Setting the Screen Orientation

You can easily switch between landscape and portrait shots by rotating your camera. HERO9 Black can even capture photos and videos right-side up when it's mounted upside down.

The orientation is locked in when you press the Shutter button . If your camera tilts during recording, like on a roller coaster, your footage will tilt with it. You'll capture every twist and turn.

LOCKING THE ORIENTATION

HERO9 Black lets you lock the screen in landscape or portrait orientation. This is especially useful when you're using body and handheld mounts. That's when accidentally shooting in the wrong orientation is mostly likely to happen.

Swipe down on the rear screen to access the Dashboard.

1. Turn your camera to the orientation you want.
2. Tap  on the Dashboard.

The screen is now locked and will match the orientation of your camera.

Heads Up: Locking the screen in this way will only work when the Orientation is set to All (default) in Preferences.

SETTING LANDSCAPE LOCK

You can also set your GoPro to record only in landscape orientation.

Swipe down on the rear screen to access the Dashboard.

1. Swipe left and tap Preferences > Displays > Orientation.
2. Switch from Auto (default) to Landscape.

Your GoPro will record right-side up whether your camera is right-side up or upside down. You can also lock the orientation on the Dashboard.

Recording Video

Your GoPro comes loaded with four video presets. Each has its own specialty. Once you've chosen your preset, press the Shutter button  to start recording.

STANDARD (DEFAULT)

A versatile preset that's great for all-purpose recording. It shoots 1080p video at 60 frames per second (fps) for full-screen playback on your phone and TV. The digital lens is set to Wide to capture more of the scene in the frame.

ACTIVITY

Use this preset to capture ultra immersive footage of your favorite activities. It records 2.7K video at 60 fps with the SuperView digital lens. This gives your video the classic GoPro look with high-resolution full-screen playback.

CINEMATIC

Captures stunning 4K high-resolution video at 30 fps. This preset uses the Linear + Horizon Leveling digital lens to smooth out the fish-eye effect and give your footage a dramatic cinematic feel with a ultra steady horizon.

SLO-MO

Great for fast-action shots, this preset records 1080p footage at 240 fps. This lets you slow things down to 8x normal speed during playback and catch amazing details you can't see with the naked eye.

Recording Video

ON-SCREEN SHORTCUTS

The video presets feature four default shortcuts, but you can swap them out with any shortcuts you'd like.

To learn more, see [Personalizing Your On-Screen Shortcuts \(page 33\)](#).

Heads Up: The Slo-Mo preset does not have default shortcuts.

Slo-Mo

Tapping the Slo-Mo shortcut automatically resets the frame rate to 120 fps. This will let you slow the footage down to 4x normal speed during playback.

Heads Up: Tapping Slo-Mo before recording 4K30 or 2.7K30 (4:3) video will bump the frame rate up to 60 fps. This will let you slow the footage down to 2x normal speed during playback. Slo-Mo is unavailable when recording in 5K.

1. Tap  before you start recording.



2. Press the Shutter button  to start recording.

Recording Video

Digital Lenses

Changing digital lenses on your GoPro is just like switching out the lenses on an old-school camera. They affect the field of view, the cropping, and the fisheye effect in your shot.

1. Tap **W**.



2. Scroll through the options to see a live preview of each option, and then tap the one that you want.



Heads Up: Some digital lenses only work with select frame rates. If needed, HERO9 Black will automatically adjust the frame rate when you switch lenses.

Recording Video

HyperSmooth Boost

Use HyperSmooth Boost to maximize video stabilization when the terrain gets rough.

1. Tap **BS** before you start recording.



2. Press the Shutter button  to start recording.

To learn more, see [HyperSmooth Video Stabilization \(page 126\)](#).

Heads Up: HyperSmooth Boost is automatically on when you choose the Narrow digital lens.

PRO TIP: HyperSmooth Boost provides ultimate video stabilization by tightly cropping the image. Turn HyperSmooth off for uncropped, unstabilized footage, or use the On or High settings for stabilized video with a wider field of view.

Recording Video

Touch Zoom

Touch Zoom helps you capture a closer view of the action.

1. Tap .



2. Use the slider to choose how much you want to zoom.



3. The zoom level is locked until you readjust it, switch capture modes, or turn off your camera.

Video Settings

Here's a breakdown of the video settings. Tap the  and then the setting to make changes.

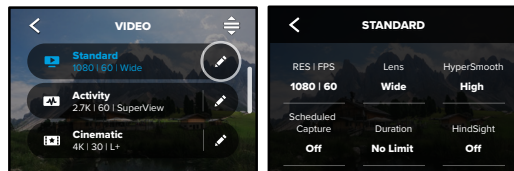



MODE (AVAILABLE WHEN CREATING A CUSTOM PRESET)

Choose the mode you want—Video (for traditional video), Looping, or Slo-Mo.

Looping

Looping lets you save space on your SD card by recording in a continuous loop until you've captured the moment you want. Use it when you're waiting for something to happen (like fishing) or when nothing may happen (like a dashcam).

Here's how it works:

- If you select 5-minute intervals, only the previous 5 minutes are saved when you press the Shutter button  to stop recording.
- If you record for 5 minutes and don't press the Shutter button , your camera will loop back and record over the start of the video.

Slo-Mo

These high-frame rate settings let you slow your footage down to 8x or 4x normal speed during playback. Set the resolution to 1080p and frame rate to 240 fps for 8x super slow motion. Choose a 2.7K, 1440p, or 1080p resolution with a frame rate of 120 fps for 4x slow motion.

Video Settings

RES | FPS

Resolutions (RES) are grouped by aspect ratio. Tall 4:3 resolutions (great for selfies and point-of-view shots) are listed in the top row. Widescreen 16:9 resolutions (great for cinematic shots) are in the bottom row.

Frames per second (fps) are listed at the bottom of the screen. Frame rates for the resolution you selected are in white. Unavailable frame rates are in gray. Use higher frame rates to capture fast action or slo-mo shots.

The default resolution and fps will vary based on the preset you choose.

To learn more, see:

- [Video Resolution \(page 133\)](#)
- [Frames per Second \(FPS\) \(page 120\)](#)
- [Aspect Ratio \(page 121\)](#)

LENS

Choose the best digital lens for your shot—SuperView, Wide, Linear, Linear + Horizon Leveling, or Narrow. The default lens will vary based on the preset. *Heads Up:* Available lenses will vary based on the resolution and frame rate you select.

To learn more, see [Digital Lenses \(Video\) \(page 122\)](#).

INTERVAL (LOOPING)

Choose how long your GoPro records before looping back to record over the start of the video. The default interval is 5 minutes.

To learn more, see [Looping Interval \(page 126\)](#).

Video Settings

HYPERSMOOTH

Perfect for biking, skiing, handheld shots, and more, HyperSmooth video stabilization delivers insanely smooth gimbal-like footage without the gimbal. The available settings are Boost, High, On, and Off.

To learn more, see [HyperSmooth Video Stabilization \(page 126\)](#).

SCHEDULED CAPTURE

Set when your GoPro will turn itself on and start recording.

DURATION

Choose how long your camera records before automatically stopping.

HINDSIGHT

Choose whether HindSight saves 15 or 30 seconds video before you press the Shutter button .

TIMER

Set up a 3- or 10-second timer for your video.

ZOOM

Touch Zoom helps you capture a closer view of the action. Use the slider on the right to lock in the zoom level.

PROTUNE

Protune gives you manual control of advanced settings, including Bit Rate, Color, ISO Limit, Exposure, and microphone settings.

To learn more, see [Protune \(starting page 137\)](#).

Taking Photos





Your GoPro has four Photo presets. Simply choose the type of photo you want and press the Shutter button  to get the shot. All photos are captured at 20MP, with the default digital lens set to Wide.

PHOTO (DEFAULT)

Use this preset to capture a single photo or a series of continuous photos. A single press of the Shutter button  will capture a single photo. Press and hold the Shutter button  to take continuous photos at a rate of up to 30 per second (depending on lighting conditions).

LIVEBURST

LiveBurst captures a burst of photos both 1.5 seconds before and 1.5 seconds after the Shutter button  is pressed. You can look through the burst to find the perfect shot or share the whole burst as a short video.

BURST

Burst captures a series of photos at blistering rates. This makes it perfect for fast-action shots. This preset automatically shoots up to 25 photos in 1 second based on lighting conditions.

NIGHT

The Night preset automatically adjusts your camera's shutter speed to let in more light for your shot. It's perfect for dim or dark scenes, but it's not recommended for handheld or mounted shots when the camera is moving.

Taking Photos

ON-SCREEN SHORTCUTS

The photo presets feature four default shortcuts, but you can swap them out with any shortcuts you'd like.

To learn more, see [Personalizing Your On-Screen Shortcuts \(page 57\)](#).

Heads Up: Output is only a default shortcut for the Photo preset, but you can also set it up in Burst and Night modes.

Photo Timer

Use the Timer to set up a selfie, group shot, and more.

1. Tap .



Taking Photos

2. Choose 3 seconds (great for selfies) or 10 seconds (great for group shots).



3. Press the Shutter button . Your camera will start the countdown. It will also beep, and the front status light will blink. Both will speed up as the time winds down before snapping the photo.

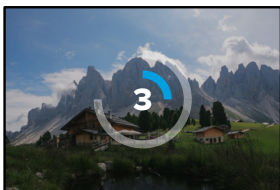

Heads Up: To help prevent blurry low-light shots, the timer is automatically set to 3 seconds when you switch to Night photo mode.

Taking Photos

Digital Lenses

Digital lenses affect the field of view, the cropping, and the fisheye effect in your photo. Switch them up to see what works best for your shot.

1. Tap .



2. Scroll through the options to see a live preview of each option, and then tap the one that you want.



Heads Up: LiveBurst uses only the Wide lens.

Taking Photos

Output

HERO9 Black lets you decide how your photos are processed and saved. Photo mode (shooting one photo at a time) gives you the most options.

Output	Mode	Description
SuperPhoto	Photo	Automatically uses advanced image processing to give you the most brilliant photos possible in any lighting. May take longer to process each shot.
HDR	Photo	Takes and combines multiple photos into a single shot. Brings out the details in scenes that mix bright light and shadows.
Standard	Photo, Burst, Night	Saves photos as standard .jpg files.
RAW	Photo, Burst, Night	Save each photo as a .jpg and .gpr files for use with your favorite photo editing programs.

Taking Photos

1. Tap .



2. Scroll through the options on the right, and then tap the one that you want.



Taking Photos

Touch Zoom

Touch Zoom helps you capture a closer view of the action.

1. Tap .

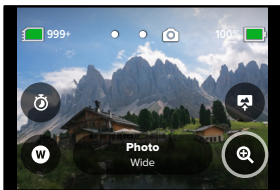

2. Use the slider to choose how much you want to zoom.



3. The zoom level is locked until you readjust it, switch capture modes, or turn off your camera.

PRO TIP: You can set up your shot using any combination of Burst, Photo Timer, and Zoom.

Photo Settings

Here's an overview of the available photo settings. Tap the  to access the settings menu, and then tap the setting itself to make changes.

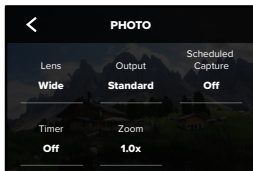
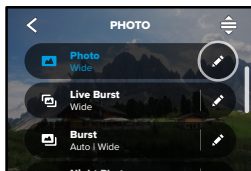

LENS

Choose best digital lens for your shot—Wide, Linear, or Narrow. Scroll through them on the right side to see a live preview of each, and then tap the one you want.

To learn more, see [Digital Lenses \(Photo\) \(starting page 130\)](#).

OUTPUT (PHOTO, BURST, NIGHT)

Set the level of processing for your shot and how the files are saved. Choose SuperPhoto, HDR, Standard, or RAW Format.

To learn more, see:

- [SuperPhoto \(starting page 127\)](#)
- [High Dynamic Range \(HDR\) \(starting page 127\)](#)
- [RAW Format \(starting page 131\)](#)

SCHEDULED CAPTURE

Set when your GoPro will turn itself on and take a photo.

Photo Settings

TIMER

Set up a 3- or 10-second timer for your photo.

ZOOM

Touch Zoom helps you capture a closer view of the action. Use the slider on the right to lock in the zoom level.

MEGAPIXELS (LIVEBURST)

Choose 8MP or 12MP resolution for your LiveBurst shots. 8MP (default) is compatible with most phones. 12MP is only compatible with the latest high-end phones.

SHUTTER (NIGHT)

Set how long your camera's shutter stays open for night shots. Choose longer exposures for darker shots.

To learn more, see [Shutter Speed \(page 129\)](#).

BURST RATE (BURST)

Choose how many photos your camera will take in a 1, 3, 6, or 10 second burst.

To learn more, see [Burst Rate \(page 129\)](#).

PROTUNE (PHOTO, BURST, NIGHT)

Protune gives you manual control of advanced settings including Shutter, Bit Rate, Color, ISO Limit, and Exposure.

To learn more, see [Protune \(starting page 137\)](#).

Capturing Time Lapse

Time Lapse turns long events into short shareable videos by taking a frame of video at set intervals. Your GoPro has three Time Lapse presets. All you have to do is press the Shutter button  to start recording, and then press it again to stop.

TIMEWARP (DEFAULT)

HERO9 Black lets you speed up time by using TimeWarp video stabilization to capture ultra smooth time lapse video while you're on the move. This preset captures 1080p video with the Wide digital lens while automatically adjusting your capture speed for the best results.

Tap the screen during recording to activate Speed Ramp. This slows down your TimeWarp to real speed or half speed. Tap the screen again speed back up.

PRO TIP: You can also use the Mode button  to activate Speed Ramp. Scroll down to Shortcuts in the setting menu to set it up.

TIME LAPSE

Use this preset to capture time lapse video when your camera is mounted and still. It's great for sunsets, street scenes, art projects, and other shots that unfold over a long period of time. It records 1080p video with the Wide digital lens while capturing a shot every 0.5 seconds.

NIGHT LAPSE

Night Lapse was made to capture time lapse video in dark and low-light environments. It automatically adjusts the shutter speed to let in more light and picks the interval that will give you the best results. It records 1080p video with the Wide digital lens. Night Lapse isn't recommended for handheld or mounted shots when the camera is moving.

PRO TIP: HERO9 Black can also capture Time Lapse and Night Lapse photos. Simply go to Format in settings and chose Photo.

Capturing Time Lapse

ON-SCREEN SHORTCUTS

The time lapse presets include two default shortcuts, but you can swap them out with any shortcuts you'd like.

To learn more, see [Personalizing Your On-Screen Shortcuts \(page 33\)](#).

PRO TIP: Although there are only two default shortcuts, you can have up to four.

Digital Lenses

Swap out digital lenses to change the field of view, the cropping, and the fisheye effect in your shot.

1. Tap .

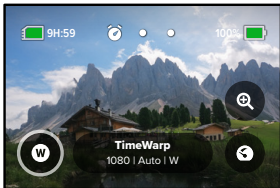

Capturing Time Lapse

2. Scroll through the options to see a live preview of each option, and then tap the one that you want.



Heads Up: Available lenses will vary based on the mode you select.

Capturing Time Lapse

Touch Zoom

Touch Zoom helps you capture a closer view of the action.

1. Tap .



2. Use the slider to choose how much you want to zoom.



3. The zoom level is locked until you readjust it, switch capture modes, or turn off your camera.

Capturing Time Lapse

Speed Ramp (TimeWarp)

Set Speed Ramp to slow your TimeWarp video down to 1x real speed (30 fps) or 0.5x half speed (60 fps).

Heads Up: Half speed is available when shooting 1440p and 1080p footage.

1. Tap  to switch Speed Ramp from real speed (default) to half speed.



2. Tap the screen while recording to slow down your video. Tap again to speed back up.

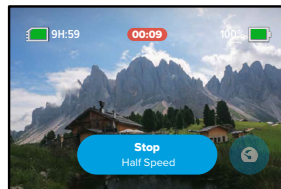

Time Lapse Settings

Here's where you can make adjustments to your Time Lapse settings.

Tap the  and then tap the setting to make changes.

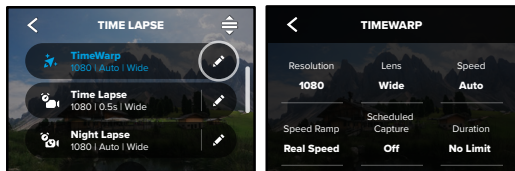

RESOLUTION

Resolutions (RES) are grouped by aspect ratio. Tall 4:3 resolutions (great for selfies and point-of-view shots) are listed in the top row. Widescreen 16:9 resolutions (great for cinematic shots) are in the bottom row.

To learn more, see:

- [Video Resolution \(TimeWarp, Time Lapse Video\) \(page 133\)](#)
- [Aspect Ratio \(page 121\)](#)

LENS

Choose best digital lens for your shot—Wide, Linear, or Narrow. Scroll through them on the right side to see a live preview of each, and then tap the one you want.

Heads Up: Available lenses will vary based on the mode you select.

To learn more, see [Digital Lenses \(Photo\) \(page 130\)](#).

Time Lapse Settings

SCHEDULED CAPTURE

Set when your GoPro will turn itself on and start recording.

DURATION

Choose how long your camera records before automatically stopping.

TIMER

Set up a 3- or 10-second timer for your time lapse.

ZOOM

Touch Zoom helps you capture a closer view of the action. Use the slider on the right to lock in the zoom level.

SPEED (TIMEWARP)

Set your video speed. Choose a lower speed (2x or 5x) for short activities or higher speeds (10x, 15x, or 30x) for longer activities. Leave speed on Auto (default) to let your GoPro automatically adjust the speed based on motion, scene detection, and lighting.

To learn more, see [TimeWarp Video Speed \(page 132\)](#).

SPEED RAMP (TIMEWARP)

Choose to slow your TimeWarp video down to real speed or half speed while recording.

To learn more, see [TimeWarp Video Speed \(page 132\)](#).

FORMAT (TIME LAPSE, NIGHT LAPSE)

Switch from capturing Time Lapse and Night Lapse video to Time Lapse and Night Lapse photo. The photo format takes a continuous series of photos at set intervals. This lets you focus on your activity instead of on your camera. You can then look through all of your photos and find the best shots later.

Time Lapse Settings

INTERVAL (TIME LAPSE)

Choose how often your camera captures a frame of video or takes a photo. Use shorter intervals for quick activities and longer intervals for extended activities.

To learn more, see *Time Lapse Interval (page 134)*.

INTERVAL (NIGHT LAPSE)

Set how often your camera takes a shot in low and ultra low-light scenes. Choose short intervals for scenes with a lot of movement and more light. Use longer intervals in scenes with little or no movement or light.

To learn more, see *Night Lapse Interval (page 136)*.

OUTPUT (TIME LAPSE PHOTO, NIGHT LAPSE PHOTO)

Save your photos as standard .jpg or RAW files.

To learn more, see *RAW Format (page 131)*.

SHUTTER (NIGHT LAPSE)

Set how long your camera's shutter stays open for night shots. Choose longer exposures for darker shots.

To learn more, see *Shutter Speed (page 129)*.



PROTUNE (TIMEWARP, TIME LAPSE VIDEO, NIGHT LAPSE VIDEO)

Take manual control of advanced video settings.

To learn more, see *Protune (starting page 137)*.

Live Streaming + Webcam Mode

SETTING UP A LIVE STREAM

1. Connect to the GoPro app. For details, see *Connecting to the GoPro App (page 85)*.
2. In the app, tap  to control your camera.
3. Tap  and follow the instructions to set up your stream.

For complete step-by-step instructions, visit gopro.com/live-stream-setup.

USING YOUR GOPRO AS A WEBCAM

Both your GoPro and computer must be set up for webcam mode before you go live. Your camera is in webcam mode by default. Connect your camera to your computer using the included USB-C cable, and then follow the step-by-step setup instructions at gopro.com/webcam.

Follow these steps if you need to put your camera in webcam mode:

1. Swipe down on the rear screen to access the Dashboard.
2. Swipe left and tap Connections > USB Connection.
3. Choose GoPro Connect.

Exposure Control

HERO9 Black scans the entire scene to choose the exposure level for your shot. Exposure Control lets you decide if only a section of the shot should be used to set the exposure.

Check out the shot preview on your touch screen. Try Exposure Control if there are sections that are too dark or too light.

SETTING EXPOSURE CONTROL USING AUTO EXPOSURE

With this option, the camera automatically bases exposure on the area that you select.

Imagine your camera is mounted on your dashboard. You probably want to set the exposure based on the scene outside instead of the dashboard. This will help prevent your shots from being overexposed (too bright).

1. Press the touch screen until a set of brackets with a dot in the middle appears in the center of the screen. This is the Spot Meter. It will base the exposure on the center of the shot.
2. Drag the brackets away from the center if you want to use another area of the shot to set the exposure. (You can also tap that area instead of dragging the brackets.)
3. Check the screen to see if the exposure looks good. Tap  in the lower right corner.

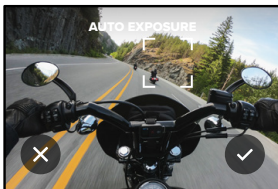

Exposure Control

SETTING EXPOSURE CONTROL USING LOCKED EXPOSURE

With this option, your camera locks the exposure until you cancel it.

If you're snowboarding on a sunny day, you might try locking the exposure on your subject's jacket. This will help prevent your shots from being underexposed (too dark) compared to the bright snow.

1. Press the touch screen until a set of brackets with a dot in the middle appears in the center of the screen. This is the Spot Meter. It will base the exposure on the center of the shot.
2. Drag the brackets away from the center if you want to use another area of the shot to set the exposure. (You can also tap that area instead of dragging the brackets.)
3. Tap inside the brackets to lock the exposure.
4. Check the screen to see if the exposure looks good. Tap  in the lower right corner to lock it in.

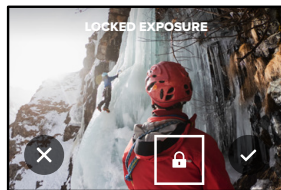

Exposure Control

Turning Exposure Control Off

Exposure Control is automatically turned off when you switch capture modes or restart your camera. It can also be turned off manually.

1. Press the touch screen until a square appears in the middle.
2. Tap  in the lower left corner.

Heads Up: After canceling Exposure Control, your camera will go back to automatically using the entire scene to set the exposure level.

Controlling Your GoPro With Your Voice

Voice Control gives you easy, hands-free control of your GoPro. It's great when you're busy with handlebars, ski poles, and more. Just tell your GoPro what you want it to do.

TURNING VOICE CONTROL ON + OFF

1. Swipe down on the rear screen to access the Dashboard.
2. Tap  to turn Voice Control on or off.

CAPTURING WITH VOICE CONTROL

With Voice Control on, you can simply tell your GoPro to start capturing.

Command	Description
GoPro, capture	Starts capturing with the mode your camera is set to.
GoPro, stop capture	Stops capture in Video and Time Lapse modes. Photo, LiveBurst, and Burst mode stop on their own.

PRO TIP: Saying “GoPro, capture” and “GoPro, stop capture” is the hands-free way of pressing the Shutter button. They will start and stop capture using the mode and settings you currently have on your camera.

Controlling Your GoPro With Your Voice

LIST OF VOICE COMMANDS

There are two types of voice commands: Action commands and Mode commands.

Using Action Commands

These commands let you switch modes on the fly. If you just recorded a video, you can say, "GoPro, take a photo" to snap a photo without manually switching modes.

Action Command	Description
GoPro, start recording	Starts recording video.
GoPro, HiLight	Adds a HiLight Tag to your video during recording.
GoPro, stop recording	Stops recording video.
GoPro, take a photo	Takes a single photo.
GoPro, shoot burst	Takes burst photos.
GoPro, start time lapse	Starts capturing with the last time lapse mode you used.
GoPro, stop time lapse	Stops capturing time lapse.
GoPro, turn on	Turns your camera on (Wake on Voice must be on).
GoPro, turn off	Turns your camera off.

Controlling Your GoPro With Your Voice

Using Mode Commands

Use these commands to switch capture modes on the go. Then say, "GoPro, capture" or press the Shutter button to get the shot.



Mode Command	Description
GoPro, Video mode	Switches your camera to Video mode (does not start recording).
GoPro, Photo mode	Switches your camera to Photo mode (does not take a photo).
GoPro, Time Lapse mode	Switches your camera to Time Lapse photo mode (does not start taking time lapse photos).

PRO TIP: If you're recording video or time lapse, you must stop recording by pressing the Shutter button or by saying, "GoPro, stop capture" before trying a new command.

Controlling Your GoPro With Your Voice

TURNING ON YOUR GOPRO WITH YOUR VOICE

With this setting, your GoPro will turn on and respond to voice commands when it's off.

1. Swipe down on the rear screen to access the Dashboard.
2. Tap  to turn on Voice Control.
3. Swipe left and tap Preferences > Voice Control > Wake on Voice > On.
4. Power off your camera by saying, "GoPro, turn off" or by pressing and holding the Mode button .
5. Turn on your camera by saying, "GoPro, turn on."

Heads Up: Your camera will listen for commands for 1 hour after you've turned it off.

SEE A COMPLETE LIST OF COMMANDS ON YOUR CAMERA

1. Swipe down on the rear screen to access the Dashboard.
2. Swipe left and tap Preferences > Voice Control > Commands.

CHANGING YOUR VOICE CONTROL LANGUAGE

1. Swipe down on the rear screen to access the Dashboard.
2. Swipe left and tap Preferences > Voice Control > Language.







Heads Up: Voice Control may be affected by wind, noise, and your distance from the camera. Keep your camera clean and wipe away any debris for the best performance.

Playing Back Your Media



Swipe up to see the last video, photo, or burst you took. Swipe left and right to flip through the other files on your SD card.



The Media Gallery includes the following playback options:

-  Pause playback
-  Resume playback
-  See all of the media on your SD card
-  Delete the file from your SD card
-  Play back at slo-mo or normal speed
-  Use a slider to scan through your videos, bursts, and time lapse photos
-  Add/remove HiLight Tag

Playing Back Your Media

-  Adjust the playback volume
-  Go to the previous or next photo in a burst or group of continuous photos

Heads Up: The playback options will vary based on the type of media you're viewing.

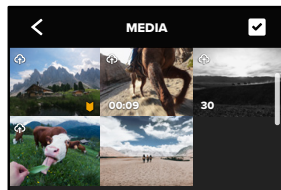

PRO TIP: Some playback options are not available when you're holding your camera in portrait orientation. Make adjustments to those settings in landscape orientation before rotating your camera.

Playing Back Your Media



USING GALLERY VIEW



Gallery view gives you quick access to all of the videos and photos stored on your SD card.

1. From the playback screen, tap .
2. Swipe up to scroll through your media.
3. Tap a video or photo to see it in full-screen view.
4. Tap  to select files.
5. Tap  to go back to the playback screen.

Heads Up: Gallery view is not available when you're holding your camera in portrait orientation. Also, the more content you have on your SD card, the longer it will take to load.

Playing Back Your Media

DELETING MULTIPLE FILES

1. Tap .
2. Tap all of the files that you want to delete. Tap a file again if you want to de-select it.
3. Tap  to delete the selected files.

VIEWING VIDEOS + PHOTOS ON A MOBILE DEVICE

1. Connect your camera to the GoPro app. For details, see [Connecting to the GoPro App \(page 85\)](#).
2. Use the controls on the app to play back, edit, and share your videos and photos.

PRO TIP: Use the GoPro app to grab still photos from videos, create short shareable videos from full-length footage, save media to your phone, and more.

VIEWING VIDEOS + PHOTOS ON A COMPUTER

To see your media on a computer, you must first save the files to the computer. To learn more, see [Transferring Your Media \(page 87\)](#).

Connecting to the GoPro App

CONNECTING TO THE GOPRO APP

Use the GoPro app to control your HERO9 Black, share videos and photos on the go, and automatically transform your footage into awesome video stories synced with effects and music.

Connecting for the First Time

1. Download the GoPro app from the Apple® App Store® or Google Play™.
2. Follow the app's on-screen instructions to connect your camera.
Heads Up for iOS®: When prompted, be sure to allow notifications from the GoPro app so you know when your video is ready.
To learn more, see [Creating a Video Story \(page 87\)](#).

After the First Time

After you've connected once, you can start connecting through your camera's Connections menu.

1. If your camera's wireless is not already on, swipe down on the rear screen to access the Dashboard.
2. Swipe left and tap Preferences > Connections > Connect Device.
3. Follow the on-screen instructions in the GoPro app to connect.

Connecting to the GoPro App

SETTING THE CONNECTION SPEED

Your GoPro is set to use the 5GHz Wi-Fi band (the fastest available) when connecting to other mobile devices.

Change the Wi-Fi band to 2.4GHz if your device or region does not support 5GHz.

1. Swipe down on the rear screen to access the Dashboard.
2. Swipe left and tap Connections > Wi-Fi Band.

Transferring Your Media

CREATING A VIDEO STORY

You can set up your GoPro to automatically send videos and photos to your phone. The GoPro app will use them to create fully edited video story complete with music and effects.

1. Connect your camera to the GoPro app. For details, see [Connecting to the GoPro App \(page 85\)](#).
2. Swipe down on the app's home screen. Shots from your most recent session will be copied to your phone and transformed into a fully edited video.
3. Tap your video to view it.
4. Make any edits you'd like.
5. Save the story or share it with your friends, family, and followers.

Finding the Best Shots

Be sure to mark your best shots with HiLight Tags. The GoPro app looks for tags when it creates videos. This helps ensure that favorite moments are included in your stories.

HERO9 Black also knows when you face the camera, smile, and more. It automatically tags these shots with data so the app can handpick them for your videos.

To learn more, see [Adding HiLight Tags \(page 46\)](#).

Transferring Your Media

TRANSFERRING TO A COMPUTER

Copy your media from your SD card to a computer for playback and editing.

1. Remove the SD card from your camera.
2. Insert the card into an SD card reader or adapter.
3. Plug the card reader into your computer's USB port, or insert the adapter into the SD card slot.
4. Copy the files to your computer.

Transferring Your Media

AUTO UPLOADING TO THE CLOUD

With a GoPro subscription, you can automatically upload your media to the cloud where you can view, edit, and share it from any device.

1. Subscribe to GoPro:
 - a. Download the GoPro app to your device from the Apple App Store or Google Play.
 - b. Follow the app's on-screen instructions to connect your camera.
 - c. If you're connecting for the first time, follow the on-screen instructions to subscribe to GoPro. Otherwise, tap  on the camera chooser screen.
2. Connect your camera to a power outlet. The upload will start automatically.

After first-time setup, your camera won't need to connect to the app to start Auto Upload.

Heads Up: Your original files remain on your camera even after they've been backed up to the cloud.

Transferring Your Media

MANUALLY UPLOADING TO THE CLOUD

Transfer your media to the cloud without waiting for your camera to fully charge. (Your GoPro must still be connected to a power outlet, and Auto Upload must be off.)

1. Subscribe to GoPro.
2. Connect your camera to a power outlet.
3. Swipe down on the rear screen to access the Dashboard.
4. Swipe left and tap Connections > GoPro Subscription > Manual Upload.

ACCESSING YOUR CLOUD MEDIA

1. Open the GoPro app on your device.
2. Tap  and select Cloud to view, edit, and share your content.

PRO TIP: Use your cloud media to create video stories with the GoPro app. Simply choose Cloud Media when you start a new story.

Transferring Your Media

TURNING OFF AUTO UPLOAD

You can keep your camera from trying to upload every time it's connected to a power outlet and fully charged.

1. Swipe down on the rear screen to access the Dashboard.
2. Swipe left and tap Connections > GoPro Subscription > Auto Upload.
3. Tap Off.

CONNECTING TO A DIFFERENT WIRELESS NETWORK

1. Swipe down on the rear screen to access the Dashboard.
2. Swipe left and tap Connections > GoPro Subscription > Networks.
3. Choose a network. The network can't be hidden or require an end-user license agreement (for example, a network in a hotel).
4. Enter the password if needed.
5. Tap  to save the network.

CHANGING YOUR GOPRO SUBSCRIPTION PREFERENCES

Manage your Auto Upload settings, set up your wireless network, and more.

1. Swipe down on the rear screen to access the Dashboard.
2. Swipe left and tap Connections > GoPro Subscription.

Heads Up: GoPro Subscription will be available in your Preferences after you've signed up.

Setting Your Connections + Preferences

USING THE DASHBOARD

With your camera in landscape orientation, swipe down on the rear screen to access the Dashboard.

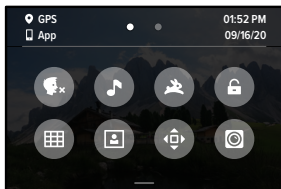

DASHBOARD FEATURES

The Dashboard lets you quickly tap the following settings on and off:



Voice Control



Camera Beeps



QuikCapture



Screen Lock



Grid



Front Screen Settings



Orientation Lock



Max Lens Mod Mode

Setting Your Connections + Preferences



CONNECTIONS

Swipe down on the rear screen to access the Dashboard, and then swipe left. Tap Connections to adjust the following settings:

Wireless Connections

Turn your camera's wireless connections on and off.

Connect Device

Choose to connect to the GoPro app or The Remote.

To learn more, see [Connecting to the GoPro App \(page 85\)](#).

USB Connection

Use GoPro Connect to set up HERO9 Black as a webcam or MTP to transfer your media to your computer.

Camera Info

See your camera's name and password.

Wi-Fi Band

Choose 5GHz or 2.4GHz as your connection speed. Set 5GHz only if your phone and region support it. To learn more, see [Setting the Connection Speed \(page 86\)](#).

Reset Connections

Clear all connections to your devices and reset your camera's password. This means you'll have to reconnect each device.

Setting Your Connections + Preferences



PREFERENCES

Swipe down on the rear screen to access the Dashboard, and then swipe left. Tap Preferences to set up your GoPro.



GENERAL

Here's everything you'll find under General settings:

Beep Volume

Choose High (default), Med, Low, or Mute. The volume you set here can be toggled on or off using the Dashboard.

QuikCapture

QuikCapture is on by default. You can turn it off here. It can also be toggled on or off using the Dashboard.

Default Preset

Set the preset your GoPro captures in when you turn it on using the Mode button . This setting does not affect QuikCapture.

Auto Power Off

Choose 5 Min, 15 Min (default), 30 Min, or Never.

LEDs

Set which status lights blink. Choose All On (default), All Off, or Front Off Only.

Setting Your Connections + Preferences

Anti-Flicker

Choose the regional frame rate for recording and playback on a TV. Set 60Hz (NTSC) for North America. Try 50Hz (PAL) if you're outside of North America. The right format for your region will help prevent flicker on a TV/HDTV when you play back video that was recorded indoors.

Video Compression

Set the file format for your videos. Choose HEVC (to reduce file sizes) or H.264 + HEVC (to use H.264 to maximize compatibility with older devices while using HEVC for advanced settings).

Time and Date

Use to manually adjust the time and date. Both are automatically updated when you connect your camera to the GoPro app.

Date Format

This is set automatically based on the language that you chose at setup. You can also change it manually here.

Setting Your Connections + Preferences



VOICE CONTROL

Choose your Voice Control settings and see all of the available commands.

Voice Control

Turn Voice Control on and off. It can also be toggled on or off using the Dashboard.

Wake on Voice

Lets you wake your camera by saying, "GoPro, turn on."

Language

Choose your Voice Control language.

Commands

See a complete list of voice commands.

To learn more, see [Controlling Your GoPro With Your Voice \(page 77\)](#).

Setting Your Connections + Preferences



DISPLAYS

Adjust Orientation, set the Screen Saver, and adjust brightness.

Orientation

Keeps your screen right-side up when you rotate your camera.

To learn more, see [Setting the Screen Orientation \(page 47\)](#).

Screen Saver Rear

Set rear screen saver to 1, 2 (default), 3, or 5 minutes. Choose Never to leave your screen on.

Heads Up: The camera buttons and Voice Control still work even when the screen is off.

Screen Saver Front

Set front screen saver to 1, 2, 3, or 5 minutes. You can also choose Never or Match Rear (default) to sync with the rear screen saver.

Brightness

Use the slider to adjust your screen's brightness.

Setting Your Connections + Preferences



REGIONAL

Turn on GPS, choose your language, and see all of your camera's regulatory information.

GPS

Turn on GPS to track your speed, distance, and more. Add data overlays using the GoPro app to show how fast, far, and high you were going in your videos. For more information and mobile device compatibility, check out gopro.com/telemetry.

Language

Choose the language that appears on the camera.



MODS

Use these settings with HERO9 Black Mods.

Max Lens Mod

Adds Max Lens Mod control to your camera's Dashboard.

Media Mod

Choose the type of external microphone you're connecting to Media Mod.

Setting Your Connections + Preferences



ABOUT

Update your GoPro, plus find your camera's name, serial number, battery condition, and software version.

GoPro Updates

Update your camera's software to ensure you have the latest features and performance upgrades.

Camera Info

Find your camera's name and serial number, and see which software version your camera is using.

Battery Info

Check your battery's health here. Be sure to use the GoPro Rechargeable Battery (HERO9 Black). Using an older GoPro battery or non-GoPro battery could greatly limit your camera's performance.



REGULATORY

See your GoPro's certifications.

Setting Your Connections + Preferences



RESET

Format your SD card or reset your camera's settings.

Format SD Card

Reformat your SD card. This will erase all of your media, so be sure to save it first.

Reset Presets

Reset the preloaded presets to their original settings and delete all custom presets.

Reset Camera Tips

See all of the camera tips from the beginning.

Factory Reset

Restore all of your camera's settings and clear all connections.

Important Messages

Problems are rare, but HERO9 Black will let you know if anything comes up. Here are some of the messages you might see.



CAMERA IS TOO HOT

The Temperature icon appears on the touch screen if your camera becomes too hot and needs to cool down. Your camera was designed to recognize when it's at risk of overheating and will shut down when needed. Simply let it sit and cool before using it again.

Heads Up: The operating ambient temperature range of your HERO9 Black is 14° F ~ 95° F (10° C ~ 35° C). High temperatures will cause your camera to use more power and drain the battery faster.

PRO TIP: Shooting video at a high resolution and frame rate will also cause your camera to heat up faster, especially in hot environments. Try switching to a lower resolution and frame rate to lower the risk of overheating your GoPro.

SD CARD ERROR

This message indicates that your camera has detected a problem with the SD card. It will automatically try to fix the problem. On very rare occasions, the only fix is to reformat the card. Unfortunately, you'll lose all of your media. Your camera will only reformat the card as a last resort.

Important Messages



REPAIRING YOUR FILE

HERO9 Black will automatically try to fix damaged files. Files can be damaged if your camera loses power while recording or if there's a problem saving the file. The File Repair icon will appear on the touch screen when a repair is in progress. Your camera will let you know when it's finished and if the file was fixed.

MEMORY CARD FULL

Your camera will let you know when your SD card is full. You'll need to move or delete some files if you want to keep recording.

BATTERY LOW, POWERING OFF

A low battery message will appear on the touch screen when the battery charge drops below 10%. If the charge runs out while recording video, your camera will stop recording, save the video, and turn itself off.

Resetting Your Camera

RESTARTING YOUR GOPRO

If your camera is not responding, press and hold the Mode button  for 10 seconds. This will restart your camera. There will be no changes to your settings.

RESTORE PRESETS TO THE DEFAULTS

This will reset all of your camera's original preset settings to the defaults.

1. Swipe down on the rear screen to access the Dashboard.
2. Swipe left and tap Preferences > Reset > Reset Presets.

Heads Up: Restoring your camera's original preset settings to their defaults will delete your custom presets.

RESETTING CONNECTIONS

This will clear your device connections and reset your camera's password. Resetting connections means you'll have to reconnect all of your devices.

1. Swipe down on the rear screen to access the Dashboard.
2. Swipe left and tap Connections > Reset Connections.

RESETTING THE CAMERA TIPS

Want to see the camera tips again? Here's how to see them all from the beginning.

1. Swipe down on the rear screen to access the Dashboard.
2. Swipe left and tap Preferences > Reset > Reset Camera Tips.

Resetting Your Camera

RESTORING FACTORY SETTINGS

This will restore all of your camera's original settings, clear all device connections, and deregister your camera from GoPro Subscription. This is useful if you're giving your camera to a friend and want to completely reset it to its original state.

1. Swipe down on the rear screen to access the Dashboard.
2. Swipe left and tap Preferences > Reset> Factory Reset.

Heads Up: Restoring the factory settings will not delete any content from your SD card or have any effect on your camera's software.

Mounting Your GoPro



1



2



3

MOUNTING HARDWARE

1. Mounting Buckle
2. Thumb Screw
3. Curved Adhesive Mount

Mounting Your GoPro

USING THE MOUNTING FINGERS

Depending on the mount you're using, you'll either use a mounting buckle or attach your GoPro directly to the mount itself.

See [Using the Adhesive Mounts \(page 108\)](#) for tips on using adhesive mounts.

1. Flip the folding fingers down into the mounting position.
2. Interlock the folding fingers on your camera with the mounting fingers on the buckle.
3. Secure your camera to the mounting buckle with a thumb screw.

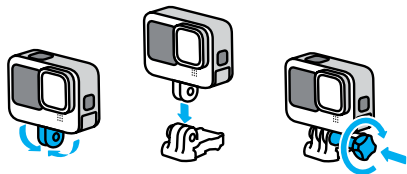

Mounting Your GoPro

4. Attach the mounting buckle to the mount.
 - a. Flip up the mounting buckle plug.
 - b. Slide the buckle into the mount until it clicks into place.
 - c. Press the plug back down so that it sits flush with the buckle.

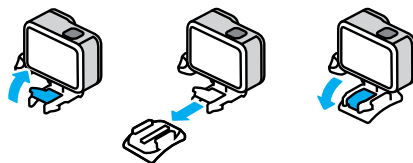

Mounting Your GoPro

USING THE ADHESIVE MOUNTS

Follow these guidelines when attaching adhesive mounts to helmets, vehicles, and gear:

- Attach mounts at least 24 hours before you use them.
- Only attach the mounts to smooth surfaces. They won't stick properly to porous or textured surfaces.
- Firmly press mounts into place. Be sure the adhesive is in full contact with the surface.
- Only use on clean, dry surfaces. Wax, oil, dirt, or other debris will weaken the bond, and you could lose your camera.
- Attach mounts in dry room temperature conditions. They won't stick properly in cold or damp environments or on cold or damp surfaces.
- Check state and local regulations and laws to ensure that attaching a camera to equipment (such as hunting gear) is permitted. Always comply with regulations that restrict the use of consumer electronics or cameras.



WARNING: To avoid injury, do not use a tether when mounting your camera on a helmet. Do not mount the camera directly on skis or snowboards.

For more information about mounts, visit gopro.com.

Mounting Your GoPro

WARNING: Always use a helmet that meets applicable safety standards if you're using a GoPro helmet mount or strap.



Choose the right helmet for your sport or activity, and make sure that it's the right size and fit for you. Check to see that your helmet's in good condition, and always follow the manufacturer's instructions on safe use.

Replace any helmet that's been subjected to a major impact. No helmet can protect against injury in every accident. Be safe.

USING YOUR GOPRO IN + AROUND WATER

HERO9 Black is waterproof to 33ft (10m) with the door locked. You won't need an additional housing before diving in.

The touch screen was designed to work when wet, but you may need to wipe it off if it has trouble sensing your commands. Although it will not work under water, you can use the camera's buttons to navigate the menus when you're submerged. To learn more, see [Navigating with the Buttons \(page 26\)](#).

PRO TIP: Use a camera tether and a Floaty (sold separately) to keep your camera afloat in case it detaches from the mount.

To capture extreme adventures down to 196ft (60m), pick up the Protective Housing (HERO9 Black), sold separately.

For more information on Camera Tethers, Floaty, and the Protective Housing, visit gopro.com.

Removing the Door

There might be times when you need to remove your camera's door.



WARNING: Only remove the door in a dry, dust-free environment. The camera is not waterproof when the door is open or removed.

REMOVING THE DOOR

1. Unlock the latch, and flip the door open.
2. With the door in a horizontal position, gently pull outward until it snaps off.

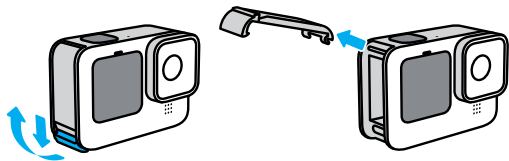

WARNING: Avoid using HERO9 Black with the door off. The battery could slide out during use.

Removing the Door

REATTACHING THE DOOR

1. Line the door up with the small silver bar.
2. Press the door tightly into the small silver bar until it snaps into place and is securely attached.

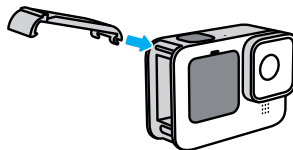

WARNING: Your camera's door is removable. Be sure that the door is securely locked and sealed after closing.

Maintenance

Follow these tips to get the best performance from your camera:

- Your GoPro is waterproof to 33ft (10m)—no housing needed. Be sure the door is closed before using it in or around water, dirt, or sand.
- Before closing the door, be sure the seal is free of debris. Use a cloth to clean the seal if needed.
- Make sure your GoPro is dry and clean before opening the door. Rinse your camera with fresh water and dry it with a cloth if needed.
- If sand or debris hardens around the door, soak your camera in warm tap water for 15 minutes and then rinse thoroughly to remove the debris. Make sure your camera is dry before opening the door.
- For the best audio performance, shake your camera or blow on the mic to remove water and debris from the microphone holes. Do not use compressed air to blow into the mic holes. This could damage the internal waterproof membranes.
- After every use in salt water, rinse your camera with fresh water, and dry it with a soft cloth.
- The lens cover is made from extremely tough strengthened glass, but it can still be scratched or cracked. Keep it clean with a soft, lint-free cloth.
- If debris gets stuck between the lens and trim ring, flush it out with water or air. Do not insert foreign objects around the lens.

Battery Information

MAXIMIZING BATTERY LIFE

Here are some things you can do to maximize battery life:

- Capture video at lower frame rates and resolutions.
- Use the Screensaver and lower the screen Brightness.
- Turn off the front screen.
- Turn off GPS.
- Turn off Wireless Connections.
- Use these settings:
 - [QuikCapture \(page 94\)](#)
 - [Auto Power Off \(page 94\)](#)

RECORDING WHEN PLUGGED INTO A POWER SOURCE

You can use the USB-C cable that came with your HERO9 Black to shoot videos and photos while your camera is plugged in to a USB-charging adapter, the GoPro Supercharger, another GoPro charger, or the GoPro Portable Power Pack. This is perfect for capturing long videos and time lapse events.

Even though your camera is charging, the battery will not charge during recording. It will start charging when you stop recording. You cannot record while your camera is plugged into a computer.

Heads Up: Because the door is open, your camera is not waterproof when charging.

Battery Information



WARNING: Using a non-GoPro wall charger could damage your camera battery and could lead to fire or leakage. With the exception of the GoPro Supercharger (sold separately), only use chargers marked Output 5V 1A. If you don't know your charger's voltage and current, use the included USB-C cable to charge your camera with a computer.

BATTERY STORAGE + HANDLING

HERO9 Black is full of sensitive components, including the battery. Avoid exposing your camera to very hot or cold temperatures. Extreme temperatures may temporarily shorten battery life or cause your camera to temporarily stop working properly. Avoid dramatic temperature or humidity changes as condensation may form on or within the camera.

Do not dry your camera with an external heat source such as a microwave oven or a hair dryer. Damage to the camera or battery caused by contact with liquid inside the camera is not covered under the warranty.

Do not store your battery with metal objects like coins, keys, or necklaces. If the battery terminals come in contact with metal objects, this may cause a fire.

Do not make any unauthorized alterations to your camera. Doing so may compromise safety, regulatory compliance, and performance, and may void the warranty.

Heads Up: Batteries have reduced capacity in cold weather. This affects older batteries even more. If you regularly shoot at low temperatures, replace batteries yearly for optimal performance.

PRO TIP: Fully charge your camera before storing it away to help maximize battery life.

Battery Information



WARNING: Do not drop, disassemble, open, crush, bend, deform, puncture, shred, microwave, incinerate, or paint your camera or battery. Do not insert foreign objects into any opening on the camera, such as the USB-C port. Do not use your camera if it's been damaged—for example, if cracked, punctured, or harmed by water. Disassembling or puncturing the integrated battery can cause an explosion or fire.

BATTERY DISPOSAL

Most rechargeable lithium-ion batteries are classified as non-hazardous waste and are safe for disposal in the normal municipal waste stream. Many regions require battery recycling. Check your local laws to make sure that you can dispose of rechargeable batteries in your regular trash. To safely dispose of lithium-ion batteries, protect terminals from exposure to other metal with packing, masking, or electrical tape so they do not cause a fire while being transported.

Lithium-ion batteries, however, do contain recyclable materials and are accepted for recycling by the Rechargeable Battery Recycling Corporation's (RBRC) Battery Recycling Program. We encourage you to visit Call2Recycle at call2recycle.org or call 1-800-BATTERY in North America to find a convenient recycling location.

Never dispose of a battery in a fire because it may explode.



WARNING: Only use GoPro replacement batteries for your camera.

Troubleshooting

MY GOPRO WON'T POWER ON

Make sure your GoPro is charged. See [MicroSD Card + Battery Setup \(page 10\)](#). If charging the battery doesn't work, try restarting your camera. See [Restarting Your GoPro \(page 103\)](#).

MY GOPRO WON'T RESPOND WHEN I PRESS A BUTTON

See [Restarting Your GoPro \(page 103\)](#).

PLAYBACK ON MY COMPUTER IS CHOPPY

Choppy playback is usually not a problem with the file. If your footage skips, one of these issues is probably the cause:

- The computer doesn't work with HEVC files. Try downloading the latest version of the GoPro Player for Mac® or Windows® for free at gopro.com/apps.
- Your computer doesn't meet the minimum requirements of the software you're using for playback.

I FORGOT MY CAMERA'S USERNAME OR PASSWORD

Swipe down on the rear screen to access the Dashboard, swipe left and then tap Preferences > Connections > Camera Info.

I DON'T KNOW WHICH SOFTWARE VERSION I HAVE

Swipe down on the rear screen to access the Dashboard, swipe left and then tap Preferences > About > Camera Info.

I CAN'T FIND MY CAMERA'S SERIAL NUMBER

The serial number is stamped inside the battery compartment of your camera. You can also find it by swiping down on the rear screen to access the Dashboard, swipe left and then tap Preferences > About > Camera Info.

For more answers to commonly asked questions, see gopro.com/help.

Tech Specs: Video

VIDEO RESOLUTION (RES)

Video resolution refers to the number of horizontal lines used in each frame of video. A 1080p video is made up of 1080 horizontal lines. A 5K video is made up of 5120 horizontal lines. Since more lines equals greater resolution, 5K will deliver a more detailed picture than 1080p.

Video Resolution	Description
5K	Our highest resolution video. Captures breathtaking ultra HD video in the 16:9 aspect ratio. Can be used to grab 14.75MP stills from your video.
4K 4:3	Ultra HD video with tall 4:3 aspect ratio captures more of the scene than 16:9 shots. Great for point-of-view footage and grabbing 12MP stills from your video.
4K	Ultra HD video with 16:9 aspect ratio. Great for tripod and fixed-position shots. Can be used to grab 8MP stills from your video.
2.7K 4:3	Great for high-resolution point-of-view body and gear-mounted shots with fluid slo-mo playback.
2.7K	High resolution 16:9 video that provides stunning, cinema-quality results for professional productions.

Tech Specs: Video

Video Resolution	Description
1440p	Tall 4:3 aspect ratio fits more into the frame than 1080p. Great for capturing fast action and point-of-view shots and for sharing to social media.
1080p	Standard HDTV resolution that's great for all shots and sharing to social media. High 240 fps and 120 fps options enable super slo-mo during editing.

Tech Specs: Video

This chart compares the frame size of each resolution:

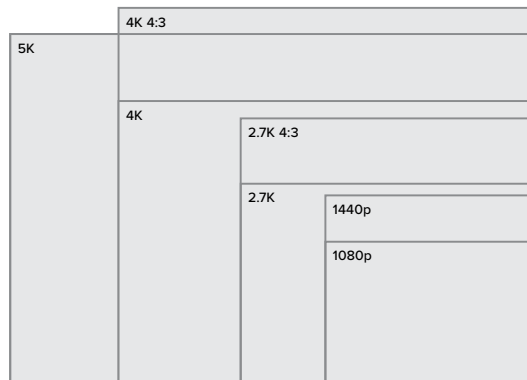

PRO TIP: Be sure that your phone, computer, or TV can support the setting you choose, especially if you're using a high resolution and frame rate.

Tech Specs: Video

FRAMES PER SECOND (FPS)

Frames per second refers to the number of frames captured in each second of video. Higher fps values (60, 120, or 240) are better at capturing fast-action shots. You can also use high fps footage for slo-mo playback.

Resolution + FPS

Higher video resolutions capture more detail and clarity, but they're generally available at lower fps values.

Lower video resolutions capture less detail and clarity, but they can be shot at higher fps values.

When choosing a resolution on the RES | FPS screen, all of the available frame rates for the resolution you selected are shown in white.

Unavailable frame rates are in gray.

Tech Specs: Video

ASPECT RATIO

Aspect ratio refers to the width and height of an image. HERO9 Black captures videos and photos in two aspect ratios.

4:3

The tall 4:3 format captures more of the scene than the 16:9 widescreen format. It's great for selfies and point-of-view footage. The 4:3 resolutions are listed in the top row of the RES | FPS screen.

16:9

This is the standard format used for HDTV and editing programs. The widescreen format is ideal for capturing dramatic cinematic footage. The 16:9 resolutions are listed below the 4:3 resolutions on the RES | FPS screen.

Heads Up: Black bars will appear on both sides of the screen when playing back 4:3 footage on an HDTV.

Tech Specs: Video

DIGITAL LENSES (VIDEO)

Digital lenses let you choose how much of the scene is captured by your camera. The different lenses also affect the zoom level and the fisheye effect in your shot. For Video mode, SuperView captures the largest field of view while Narrow captures the smallest.

Digital Lens	Description
SuperView (16mm)	Widest and tallest field of view, served up as 16:9 video.
Wide (16–34mm)	Wide field of view that captures as much as possible within the frame.
Linear (19–39mm)	Wide field of view without the fisheye effect of SuperView and Wide.
Linear + Horizon Leveling (19–39mm)	<p>Captures a wide field of view without the fisheye effect of SuperView and Wide. Keeps your footage smooth and level even if your camera tilts while recording.</p> <p><i>Heads Up:</i> Your footage will tilt if your camera rotates beyond 28°-45° (depending on chosen settings) while recording.</p>
Narrow (27mm)	Narrow field of view without the fisheye effect of SuperView and Wide.

Heads Up: Only the lenses that are compatible with the resolution and frame rate you selected will be available.

Tech Specs: Video

HERO9 BLACK VIDEO SETTINGS

Here's a rundown of your camera's video resolutions along with available fps, lenses, and aspect ratio for each.

Video Resolution (RES)	FPS (60Hz/Digital 50Hz)*	Lenses	Screen Resolution	Aspect Ratio
5K	30/25 24/24	Wide, Linear, Linear + Horizon Leveling, Narrow	5120x2880	16:9
4K	60/50	Wide, Linear, Linear + Horizon Leveling, Narrow	3840x2160	16:9
4K	30/25 24/24	SuperView, Wide, Linear, Linear + Horizon Leveling, Narrow	3840x2160	16:9
4K 4:3	30/25 24/24	Wide, Linear, Linear + Horizon Leveling, Narrow	4096x3072	4:3

*60Hz (NTSC) and 50Hz (PAL) refer to the video format, which depends on your region. To learn more, see [Anti-Flicker \(page 95\)](#).

For tips on which settings to use, see [Suggested Settings \(page 31\)](#).

Tech Specs: Video

Video Resolution (RES)	FPS (60Hz/Digital 50Hz) ¹	Digital Lenses	Screen Resolution	Aspect Ratio
2.7K	120/100 60/50	SuperView, Wide, Linear, Linear + Horizon Leveling, Narrow	2704x1520	16:9
2.7K 4:3	60/50	Wide, Linear, Linear+ Horizon Leveling, Narrow	2704x2028	4:3
1440p	120/100 60/50 30/25 24/24	Wide, Linear, Linear + Horizon Leveling, Narrow	1920x1440	4:3
1080p	240/200	Wide, Linear, Linear + Horizon Leveling, Narrow	1920x1080	16:9
1080p	120/100 60/50 30/25 24/24	SuperView, Wide, Linear, Linear + Horizon Leveling, Narrow	1920x1080	16:9

¹60Hz (NTSC) and 50Hz (PAL) refer to the video format, which depends on your region. To learn more, see [Anti-Flicker \(page 95\)](#).

For tips on which settings to use, see [Suggested Settings \(page 31\)](#).

Tech Specs: Video



High Resolutions/High Frame Rates

Shooting high-resolution or high-fps video when it's warm out can cause your camera to heat up and use more power.

Lack of airflow and connecting to the GoPro app can cause your camera to warm up even more, use even more power, and shorten recording time.

If heat's a problem, try recording shorter videos. Also limit use of features that take a lot of power, such as the GoPro app. The GoPro Smart Remote (sold separately) can control your GoPro while using less energy.

Your camera will tell you if it needs to shut down and cool off. To learn more, see [Important Messages \(page 101\)](#).

Tech Specs: Video

HYPERSMOOTH VIDEO STABILIZATION

HyperSmooth delivers ultra smooth footage by correcting for camera shake. It crops your videos while recording, which lets it buffer the footage. This makes it perfect for biking, skating, skiing, handheld shots, and more. HERO9 Black has four HyperSmooth settings:

Setting	Description
Boost	Maximum video stabilization with tight cropping.
High	Stronger video stabilization with minimal cropping (Wide lens is cropped by 10%).
On	Stabilized video with minimal cropping (Wide lens is cropped by 10%).
Off	Records without video stabilization or cropping.

PRO TIP: You can smooth out your footage even more by using Touch Zoom to crop your shots before you start recording. This will give your camera an even bigger buffer to use when stabilizing your video. Using the Linear + Horizon Leveling lens will also enhance stabilization.

LOOPING INTERVAL

You can set your GoPro to record 5 (default), 20, 60, or 120 minute loops. It can also be set to Max, which will record until your SD card is full before looping back to record over the start of the video.

Tech Specs: Photo

SUPERPHOTO

SuperPhoto automatically analyzes the scene and intelligently applies the best image processing for the shot.

Depending on the lighting, movement in your shot, and other conditions, SuperPhoto will choose one of four options:

High Dynamic Range (HDR)

Our improved HDR takes and combines multiple photos into a single shot to bring out the details in scenes that mix bright light and shadows.

Local Tone Mapping

Enhances photos by boosting the details and contrast only where it's needed.

Multi-Frame Noise Reduction

Automatically combines multiple shots into a single photo with less digital distortion (noise).

No Additional Processing

Captures photos with no advanced processing when conditions are perfect.

SuperPhoto only works for single photos. Because of the extra time needed to apply image processing, it may take a little longer to process and save each shot.

Heads Up: SuperPhoto does not work with RAW photos, Protune, or Exposure Control.

Tech Specs: Photo

Turning On SuperPhoto

SuperPhoto is off by default. Here's how to turn it on.

1. From the Photo settings screen, tap Output.
2. Select SuperPhoto.

HDR

High Dynamic Range (HDR) is one of the image-processing techniques SuperPhoto uses to enhance your shots. It combines multiple shots into a single photo with better results than ever. Choose this setting if you want to use HDR every time you take a photo.

1. From the Photo settings, tap Output.
2. Select HDR.

HDR On can only be used for single photos. For the best results, use it in high-contrast shots with minimal motion.

Heads Up: HDR does not work with RAW or Exposure Control.

Tech Specs: Photo

SHUTTER SPEED (NIGHT + NIGHT LAPSE PHOTO)

Shutter speed lets you decide how long your camera's shutter stays open in Night and Night Lapse Photo modes. Here are your options, plus tips on when to use them:

Speed	Examples
Auto (up to 30 seconds)	Sunrise, sunset, dawn, dusk, twilight, night.
2, 5, 10, or 15 seconds	Dawn, dusk, twilight, traffic at night, Ferris wheel, fireworks, light painting.
20 seconds	Night sky (with light).
30 seconds	Night stars, Milky Way (complete darkness).

PRO TIP: To reduce blur when using Night and Night Lapse photo, mount your camera on a tripod or place it on a stable surface where it won't wobble or shake.

BURST RATE

Capture fast-action scenes with one of these high-speed settings:

- Auto (up to 25 photos in 1 second based on lighting conditions)
- 30 photos in 3, 6, or 10 seconds
- 25 photos in 1 second
- 10 photos in 1 or 3 seconds
- 5 photos in 1 second
- 3 photos in 1 second

Tech Specs: Photo

DIGITAL LENSES (PHOTO)

Digital lenses let you choose how much of the scene is captured by your camera. They also affect the zoom level and fisheye effect in your shot. There are three lens options for photos:

Digital Lens	Description
Wide (16–34mm)	Wide field of view that captures as much as possible within the frame.
Linear (19–39mm)	Wide field of view without the fisheye effect of Wide.
Narrow (27mm)	Narrow field of view without the fisheye effect of Wide.

Tech Specs: Photo

RAW FORMAT

When this setting is turned on, all photos are saved as a .jpg image (for viewing on your camera or sharing with the GoPro app) and a .gpr file. The .gpr file is based on the Adobe® DNG format. These files can be used in Adobe Camera Raw (ACR), version 9.7 or later. You can also use Adobe Photoshop® Lightroom® CC (2015.7 release or later) and Adobe Photoshop® Lightroom® 6 (version 6.7 or later).

In Photo mode, RAW Format is available for Photo, Burst, Night, Time Lapse photo, and Night Lapse photo, with these conditions and exceptions:

- SuperPhoto must be off.
- Digital lenses must be set to Wide.
- Zoom must be off.
- RAW Format is not available for capturing continuous photos.
- For Time Lapse photo, the Interval must be at least 5 seconds.
- For Night Lapse photo, the Shutter setting must be at least 5 seconds.

PRO TIP: Photos in .gpr format are saved in the same location and with the same file name as .jpg files. To access the files, insert your SD card into a card reader and locate them with your computer's file explorer.

Tech Specs: Time Lapse

TIMEWARP VIDEO SPEED

You can increase TimeWarp video speed up to 30x to turn longer activities into shareable moments. The default setting is Auto, which automatically sets the speed for you.

You can also set the speed yourself. Use this chart to estimate the length of your videos. For example, recording at 2x speed for 4 minutes will give you about 2 minutes of TimeWarp video.

Speed	Recording Time	Video Length
2x	1 minute	30 seconds
5x	1 minute	10 seconds
10x	5 minutes	30 seconds
15x	5 minutes	20 seconds
30x	5 minutes	10 seconds

Heads Up: Recording times are approximate. The video length may vary depending on the movement in your shot.

Speed	Examples
2x–5x	Driving through a scenic route.
10x	Hiking and exploring.
15x–30x	Running and mountain biking.

PRO TIP: For the best results, leave the speed on the Auto setting when shooting footage that may get bumpy.

Tech Specs: Time Lapse

SPEED RAMP (TIMEWARP)

Tap the rear touch screen while recording TimeWarp to ramp down the speed of your video. Tap again to speed it back up. Choose the speed before recording by tapping  on the capture screen or going to the TimeWarp settings menu. There are two options:

Speed	Frames per Second	Sound
Real Speed (1x)	30 fps	On
Half Speed (0.5x slo-mo)	60 fps	Off

PRO TIP: You can also use the Mode button  to activate Speed Ramp. Scroll down to Shortcuts in the setting menu to set it up.

VIDEO RESOLUTION (TIMEWARP, TIME LAPSE VIDEO)

HERO9 Black shoots TimeWarp and Time Lapse video in four resolutions:

Resolution	Aspect Ratio
4K	16:9
2.7K	4:3
1440p	4:3
1080p	16:9

To learn more, see:

- [Video Resolution \(page 133\)](#)
- [Aspect Ratio \(page 121\)](#)

Tech Specs: Time Lapse

TIME LAPSE INTERVAL

The Interval sets how often your camera takes a shot in Time Lapse video and Time Lapse photo modes.

Available intervals are 0.5 (default), 1, 2, 5, 10, and 30 seconds; 1, 2, 5, and 30 minutes; and 1 hour.

Interval	Examples
0.5–2 seconds	Surfing, biking, or other sports.
2 seconds	Busy street corner.
5–10 seconds	Clouds or outdoor scenes for long durations.
10 seconds–1 minute	Art projects or other lengthy activities.
1 minute–1 hour	Construction work or other activities that take place over a very long period of time.

Tech Specs: Time Lapse

Time Lapse Video Recording Time

Use this chart to determine the length of your videos.

Interval	Recording Time	Video Length
0.5 second	5 minutes	20 seconds
1 second	5 minutes	10 seconds
2 seconds	10 minutes	10 seconds
5 seconds	1 hour	20 seconds
10 seconds	1 hour	10 seconds
30 seconds	5 hours	20 seconds
1 minute	5 hours	10 seconds
2 minutes	5 hours	5 seconds
5 minutes	10 hours	4 seconds
30 minutes	1 week	10 seconds
1 hour	1 week	5 seconds

PRO TIP: For the best results, mount your camera on a tripod or place it on a stable surface where it won't wobble or shake. Use TimeWarp video to capture time lapse video when you're on the move.

Tech Specs: Time Lapse

NIGHT LAPSE INTERVAL

Choose how often your GoPro snaps a shot in Night Lapse mode. Night Lapse intervals are Auto; 4, 5, 10, 15, 20, and 30 seconds; and 1, 2, 5, 30, and 60 minutes.

Auto (default) syncs the Interval with the Shutter setting. If the shutter speed is set to 10 seconds and the Interval is set to Auto, your camera will take a shot every 10 seconds.

Interval	Examples
Auto	Great for all exposures (captures as quickly as possible depending on the Shutter setting).
4–5 seconds	Evening city scene, street lighting, or scenes with movement.
10–15 seconds	Dim lighting with slow scene changes, such as night clouds with a bright moon.
20–30 seconds	Very low light or very slow scene changes, like stars with minimal ambient or street light.

Tech Specs: Protune

Protune unlocks your camera's full creative potential by giving you manual control of advanced settings, including Color, White Balance, and Shutter Speed. It's compatible with professional color correction tools and other editing software.

Here are some things to keep in mind:

- Protune is available for all modes except Looping and LiveBurst. Scroll down in the settings menu to see all of the Protune settings.
- Some Protune settings are not available when you use Exposure Control.
- Changes to Protune settings in one preset apply only to that preset. For example, changing the White Balance for Time Lapse does not affect White Balance for Burst photos.

PRO TIP: You can restore all Protune settings to their defaults by tapping  in the settings menu.

BIT RATE

Bit rate determines the amount of data used to record a second of video. HERO9 Black lets you choose between high or low.

Bit Rate	Description
Low (default)	Use a lower bit rate to minimize file sizes.
High	Use higher bit rates up to 100Mbps (4K and 2.7K video) for optimal image quality.

Tech Specs: Protune

COLOR

Color lets you adjust the color profile of your videos or photos. Scroll between the options to see a live preview of each setting, and then tap the one you want.

Color Setting	Description
GoPro Color (default)	Captures photos and videos with the classic GoPro color-corrected profile.
Flat	Provides neutral color profile that can be color-corrected to better match footage captured with other equipment, offering more flexibility in post-production. Due to its long curve, Flat captures more details in shadows and highlights.

WHITE BALANCE

White Balance lets you adjust the color temperature of videos and photos to optimize for cool or warm lighting conditions. Scroll between the options to see a live preview of each setting, and then tap the one you want.

Options for this setting are Auto (default), 2300K, 2800K, 3200K, 4000K, 4500K, 5000K, 5500K, 6000K, 6500K, and Native. Lower values will give you warmer tones.

You can also choose Auto to let your GoPro set the White Balance or the Native setting to create a minimally color-corrected file that allows for more precise adjustments in post-production.

Tech Specs: Protune

ISO MINIMUM/MAXIMUM

ISO Minimum and ISO Maximum let you set a range for the camera's sensitivity to light and image noise. Image noise refers to the degree of graininess in the shot.

In low light, higher ISO values result in brighter images but with more image noise. Lower values result in darker images with less image noise. Scroll between the options to see a live preview of each setting, and then tap the one you want.

The default for ISO Maximum is 3200 for both videos and photos. The default for ISO Minimum is 100.

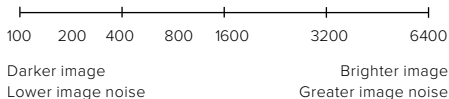

Heads Up: For the Video and Photo modes, ISO behavior depends on the Protune Shutter setting. The ISO Maximum that you select is used as the maximum ISO value. The ISO value that is applied might be lower depending on the lighting conditions.

PRO TIP: To lock the ISO at a specific value, set ISO Minimum and ISO Maximum to the same values.

Tech Specs: Protune

SHUTTER

The Protune Shutter setting only applies to the Video, Photo, and LiveBurst modes. This setting determines how long the shutter stays open. Scroll between the options to see a live preview of each setting, and then tap the one you want. The default setting is Auto.

For Photo, the options are Auto, 1/125, 1/250, 1/500, 1/1000, and 1/2000 second.

For Video, the options depend on the fps setting, as shown below.

Shutter	Example 1: 1080p30	Example 2: 1080p60
Auto	Auto	Auto
1/fps	1/30 sec	1/60 sec
1/(2xfps)	1/60 sec	1/120 sec
1/(4xfps)	1/120 sec	1/240 sec
1/(8xfps)	1/240 sec	1/480 sec
1/(16xfps)	1/480 sec	1/960 sec

PRO TIP: To reduce the amount of blur in videos and photos when using the Shutter setting, mount your camera on a tripod or other stable surface where it won't wobble or shake.

Tech Specs: Protune

EXPOSURE VALUE COMPENSATION (EV COMP)

Exposure Value Compensation affects the brightness of your photos and videos. Adjusting this setting can improve image quality when shooting scenes with sharply contrasting lighting conditions.

Options for this setting range from -2.0 to +2.0. The default setting is 0.

Scroll between the options on the right side of the EV Comp screen to see a live preview of each setting, and then tap the one you want. Higher values result in brighter images.

Heads Up: For Video, this setting is available only if Shutter is set to Auto.

You can also adjust the exposure based on a certain area of your scene. To learn more, see [Exposure Control \(page 74\)](#).

PRO TIP: EV Comp adjusts brightness within the existing ISO setting. If brightness has already reached the ISO setting in a low-light environment, increasing the EV Comp does not have any effect. To continue increasing the brightness, select a higher ISO value.

Tech Specs: Protune

SHARPNESS

Sharpness controls the quality of details captured in your video footage or photos. Options for this setting are High (default), Medium, and Low.

Scroll between the options to see a live preview of each setting, and then tap the one you want.

PRO TIP: If you plan to increase sharpness during editing, select Low for this setting.

Tech Specs: Protune

RAW AUDIO

This setting creates a separate .wav file for your video, in addition to the standard .mp4 audio track. You can select the level of processing to apply to the RAW audio track.

RAW Setting	Description
Off (default)	No separate .wav file is created.
Low	Applies minimal processing. Ideal if you want to apply audio processing in post-production.
Med	Applies moderate processing based on the Wind-Noise Reduction setting. Ideal if you want to apply your own gain.
High	Applies full audio processing (automatic gain and Wind-Noise Reduction). Ideal if you want processed audio without AAC encoding.

Insert your SD card into a card reader to access the .wav files with your computer. They're saved with the same name and in the same location as the .mp4 files.

Tech Specs: Protune

WIND-NOISE REDUCTION

Your HERO9 Black uses three microphones to capture sound while recording video. You can customize how they're used based on conditions where you're shooting and the type of sound you want in your finished video.

Setting	Description
Auto (default)	Automatically filters out excessive wind (and water) noise.
On	Use to filter out excessive wind noise or when your GoPro is mounted on a moving vehicle.
Off	Use when wind will not affect sound quality and you want to ensure that your GoPro is recording in stereo.

Customer Support

GoPro is dedicated to providing the best possible service. To reach GoPro Customer Support, visit gopro.com/help.

Trademarks

GoPro, HERO and their respective logos are trademarks or registered trademarks of GoPro, Inc. in the United States and other countries. © 2021 GoPro, Inc. All rights reserved. For patent information, visit gopro.com/patents. GoPro, Inc., 3025 Clearview Way, San Mateo CA 94402 | GoPro GmbH, Floessergasse 2, 81369 Munich, Germany

Regulatory Information

To see the complete list of country certifications, refer to the Important Product + Safety Instructions included with your camera or visit gopro.com/help.

